

INDICE	REP.	Modifications	DATE	NOM
C	.	Largeur 339 -> 335 + Châti files et glissières	22/12/04	Remi
.

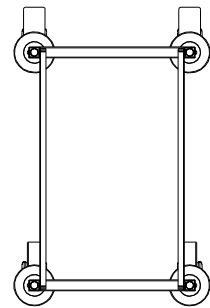
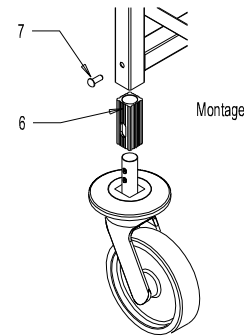
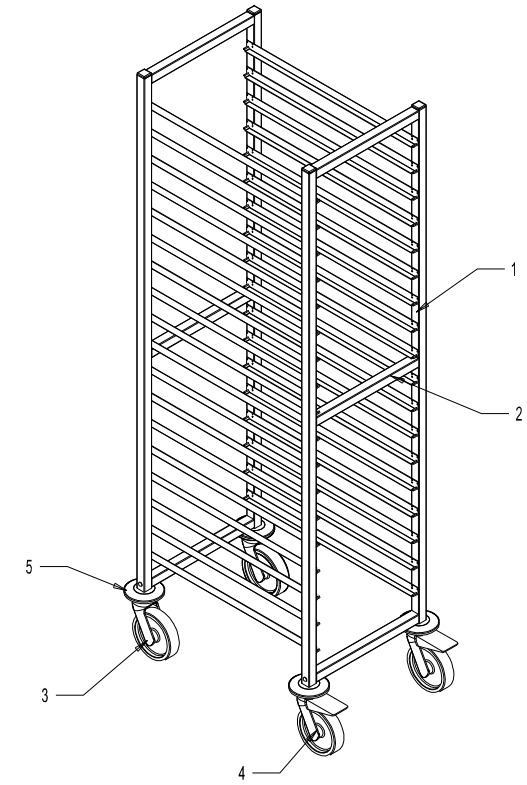
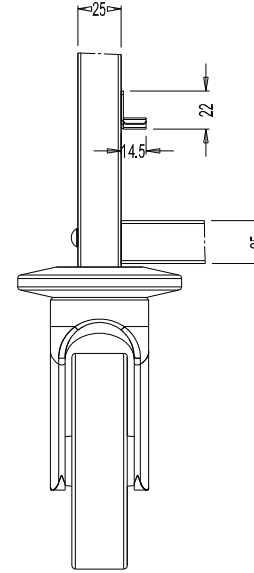
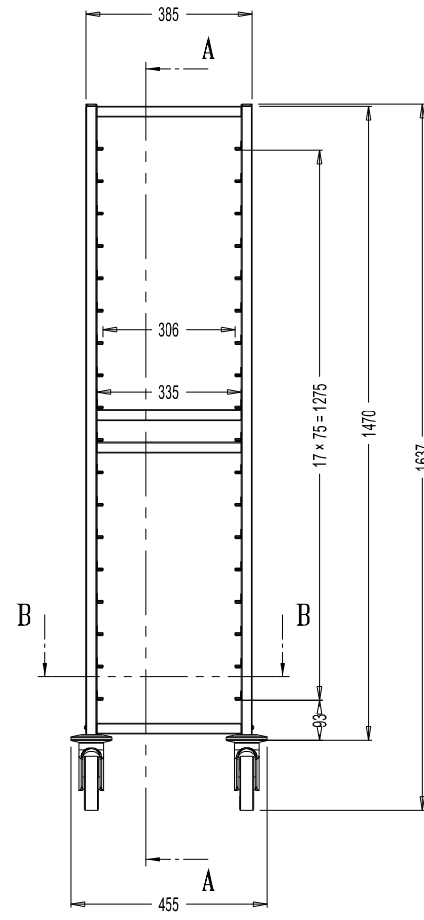
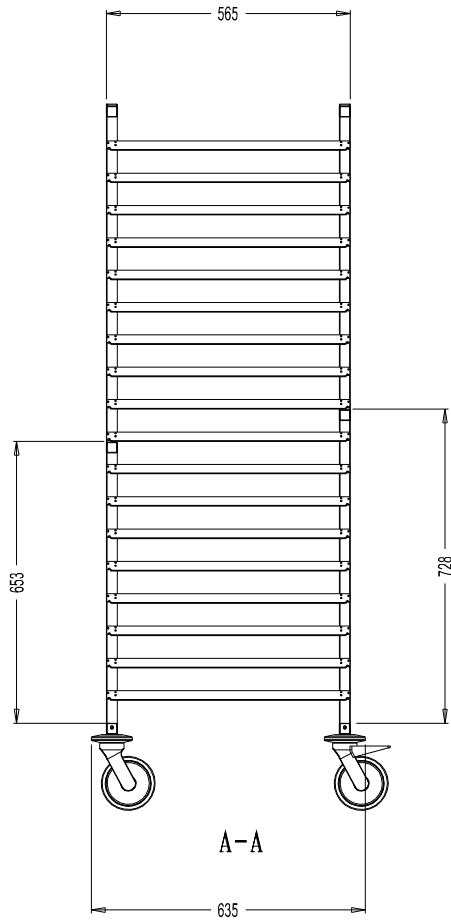

B-B

8	EMBOUR CARRE	4	25x25	DIV000008
7	VIS TB M6x16 TORX	4		VISV000053
6	ENTRETOISE CARREE	4		RLTD000010
5	BUTOIR	4	Ø95	RLTB000011
4	ROULETTE AVEC FREIN	2	Ø125	RLTP000012
3	ROULETTE SANS FREIN	2	Ø125	RLTP000011
2	TUBE 25x25x1.2	6	335	CHRSE00002
1	ECHELLE 11 - 18 NIVEAUX	2	1470x565	CHRSE01118

Repère	Désignation	Nb	Dimension	Référence
<p>CHARIOT 1/1 18 NIVEAUX - PAS 75 mm</p>				
<p>Référence : CHGAP10710</p>				Dessiné par : REMI
<p>Matériau : XS CrNi 18.10 (ANSI 304)</p>				Le : 12/02/02
<p>Traitement : DECAP+PASSIV</p>				Indice : C

< 500 mm	± 1
500 - 1000 mm	± 2
> 1000 mm	± 5
∥ ∟	2

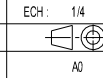

ECH : 1/4