

INDICE	REP.	Modifications	DATE	NOM
C	.	Largeur 339 -> 335 + Chgt files et glissières	22/12/04	Remi
.

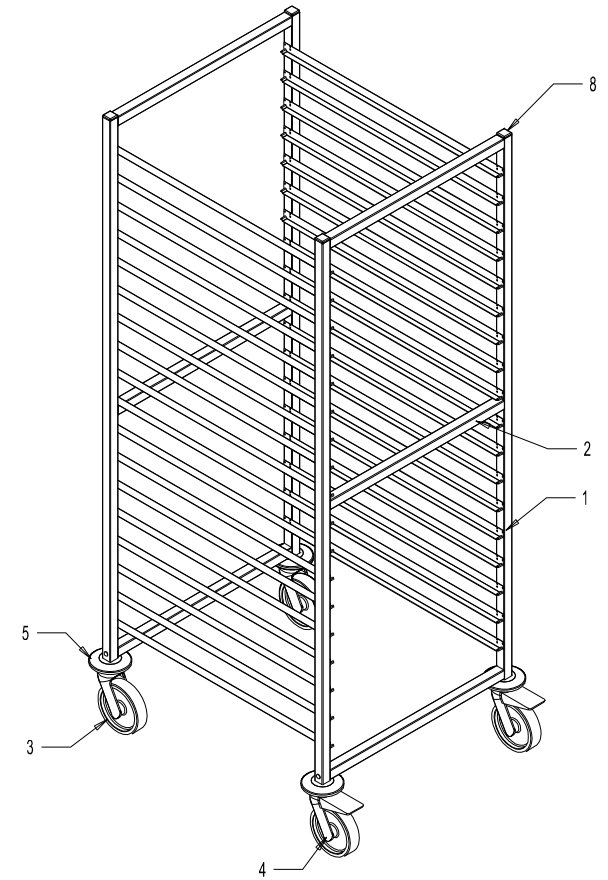

Repère	Désignation	Nb	Dimension	Référence
8	EMBOUT CARRE	4	25x25	DIV0000008
7	VIS TB M6x16 TORX	4		MSV000053
6	ENTRETOISE CARREE	4		RLTD000010
5	BUTOIR	4	Ø95	RLTB000011
4	ROULETTE AVEC FREIN	2	Ø125	RLTP000012
3	ROULETTE SANS FREIN	2	Ø125	RLTP000011
2	TUBE 25x25x1.2	6	540	CHRSE00003
1	EHELLE 2/1 - 18 NIVEAUX	2	1470x565	CHRSE02118
CHARIOT 2/1 18 NIVEAUX - PAS 75 mm				
Référence : CHGAP10711				Dessiné par : REMI
Matériau : X5 CrNi 18.10 (AISI 304)				Le : 12/02/02
Indice : C				Traitement : DECAP+PASSIV

< 500 mm	± 1
500 - 1000 mm	± 2
> 1000 mm	± 5
□ // ⊥	2

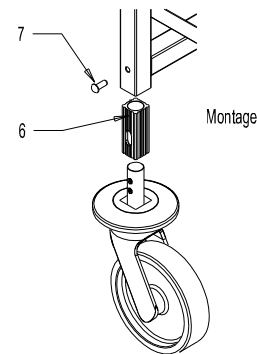
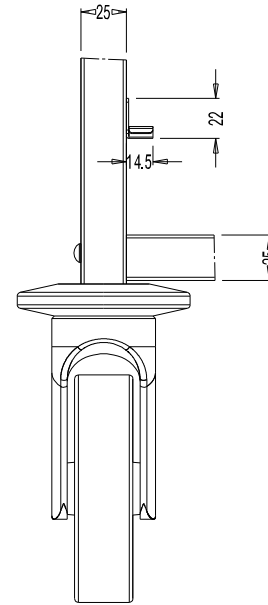
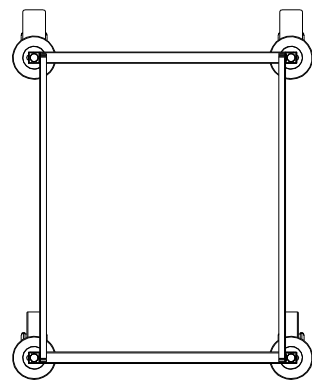
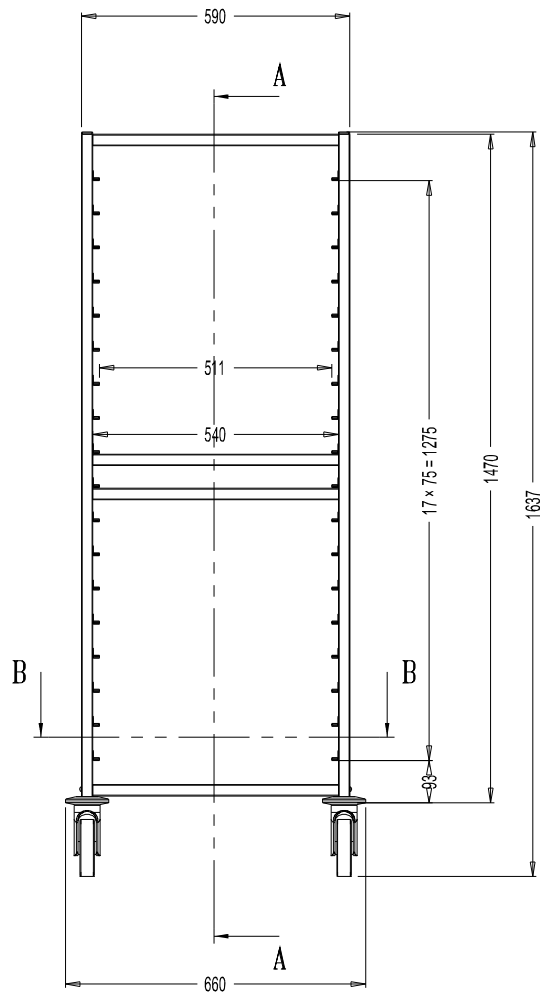
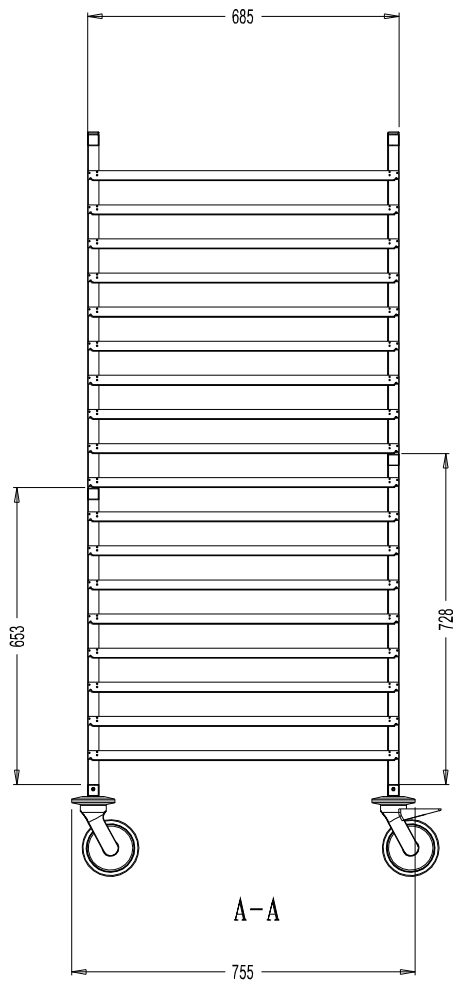
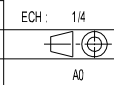

B-B